

Technical Datasheet

Consolidation Point 10" 1U
 Article No.: CPPF01KS1E

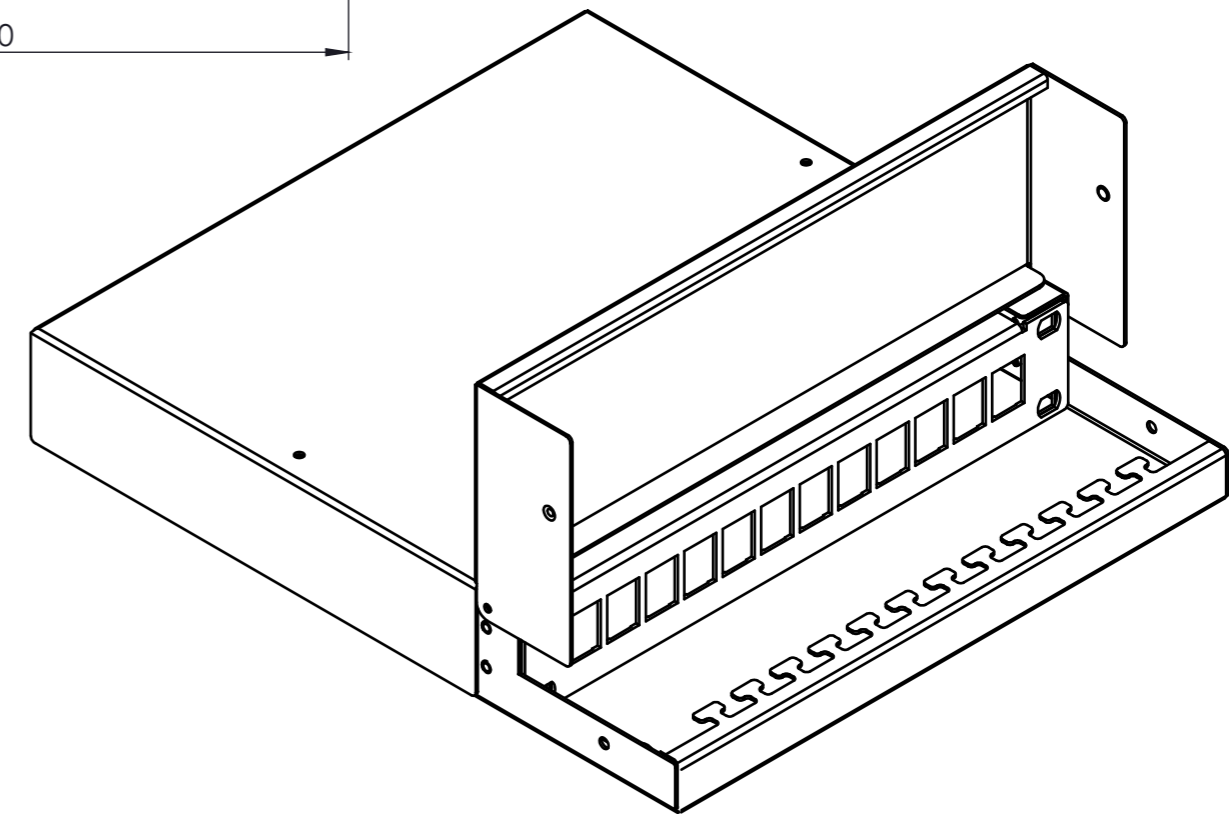
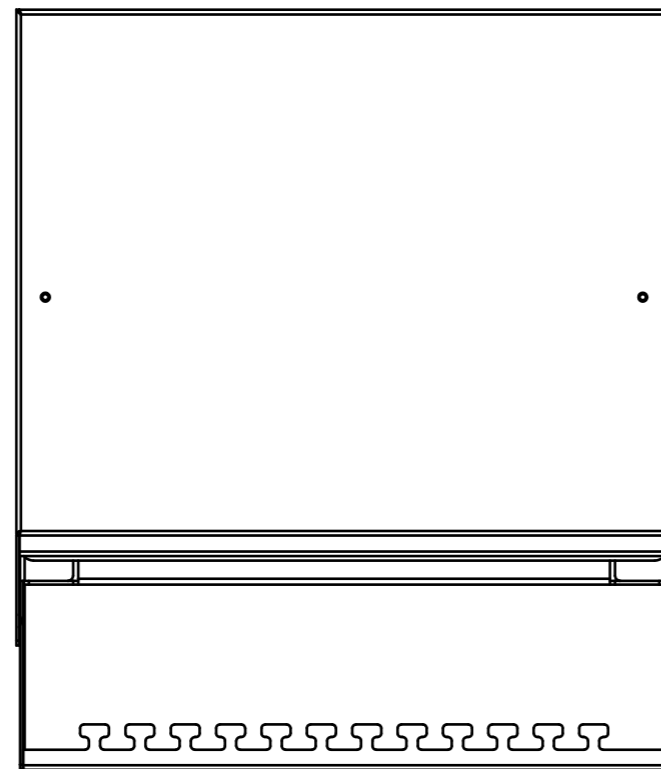
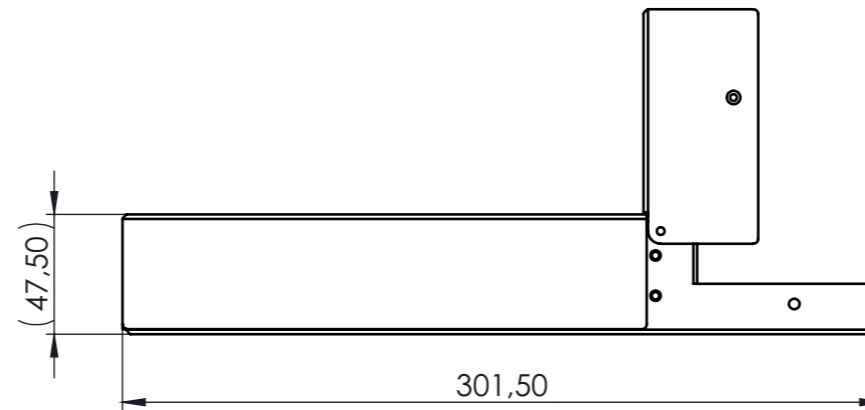
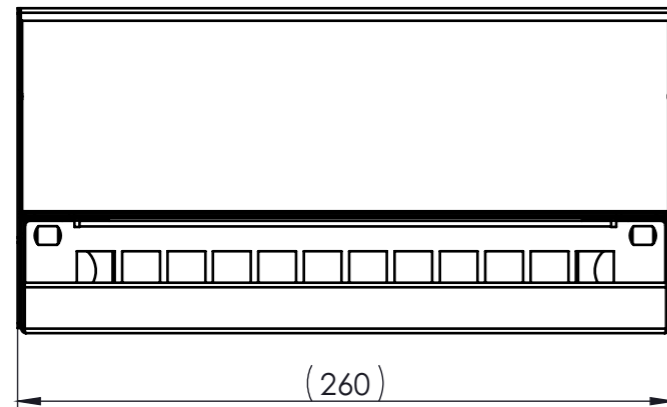

Material powder-coated sheet steel

				drawn	01.03.2015	AK	
				appr.	01.03.2015	MJ	
				Titel:			Dimensions: mm
				Consolidation Point 10" 1HE			Original: DIN A4
				Drawing number:			Sheet 1 of 1
b a	Änderung Spr. Neuerstellung	08.12.2023 01.03.2015	TG AK	ZN-BL151025			
Index	Revision code	Date	Name				

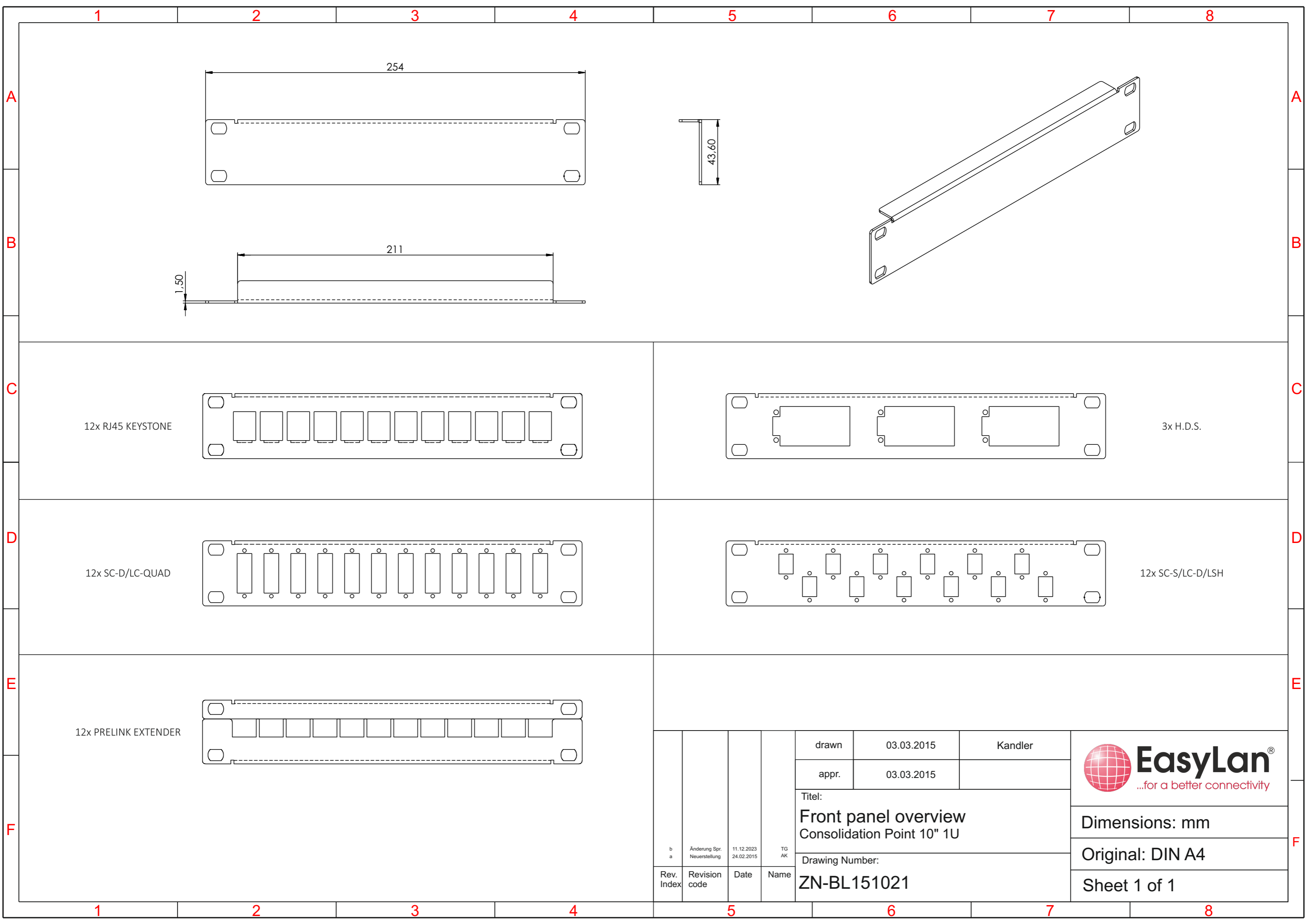

12x RJ45 KEYSTONE

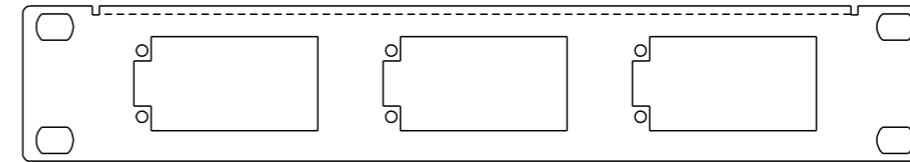
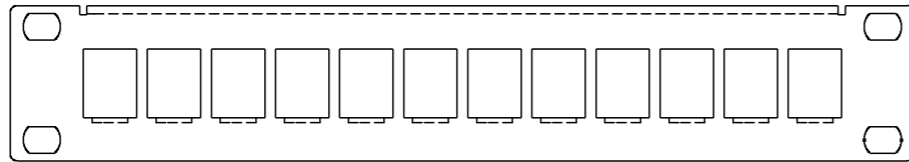

3x H.D.S.

12x SC-D/LC-QUAD

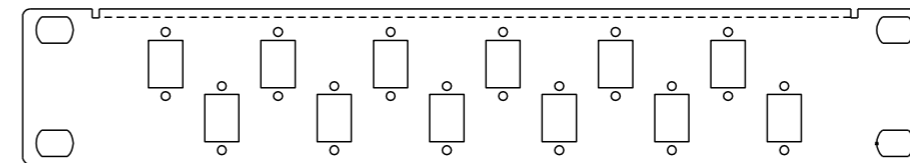
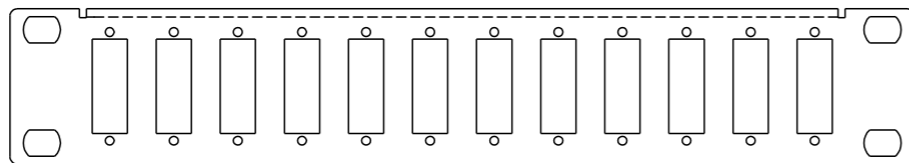

12x SC-S/LC-D/LSH

12x PRELINK EXTENDER

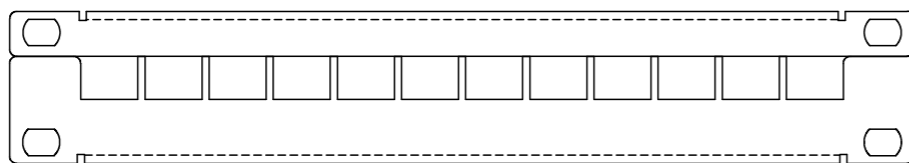

drawn	03.03.2015	Kandler
appr.	03.03.2015	
Titel:		
Front panel overview Consolidation Point 10" 1U		
Drawing Number:		
ZN-BL151021		



Dimensions: mm

Original: DIN A4

Sheet 1 of 1

b	Änderung Spr.	11.12.2023	TG
a	Neuerstellung	24.02.2015	AK
Rev. Index	Revision code	Date	Name