

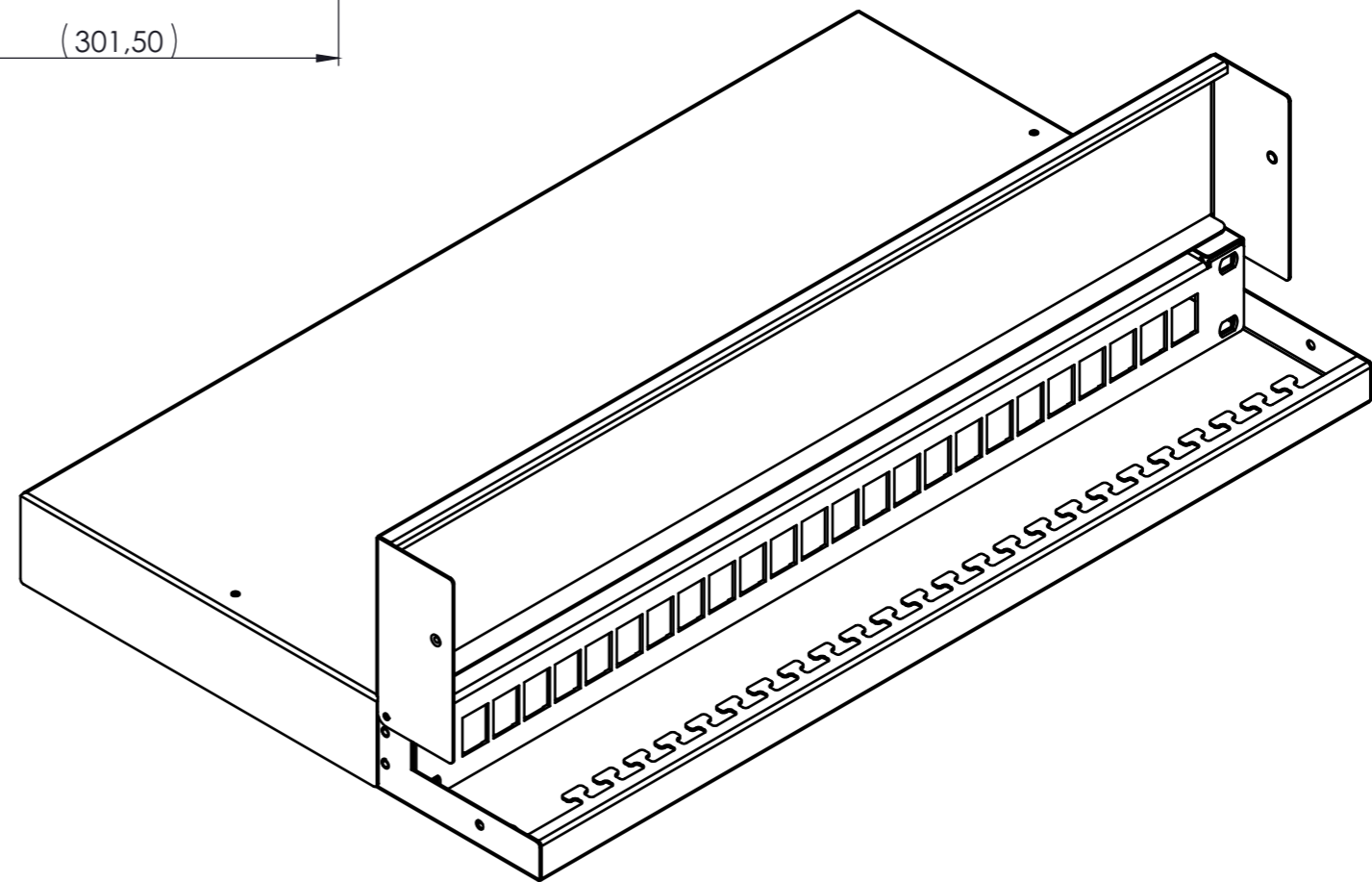

Technical Datasheet

Consolidation Point 19" 1U
 Article No.: CPPF09KS1E

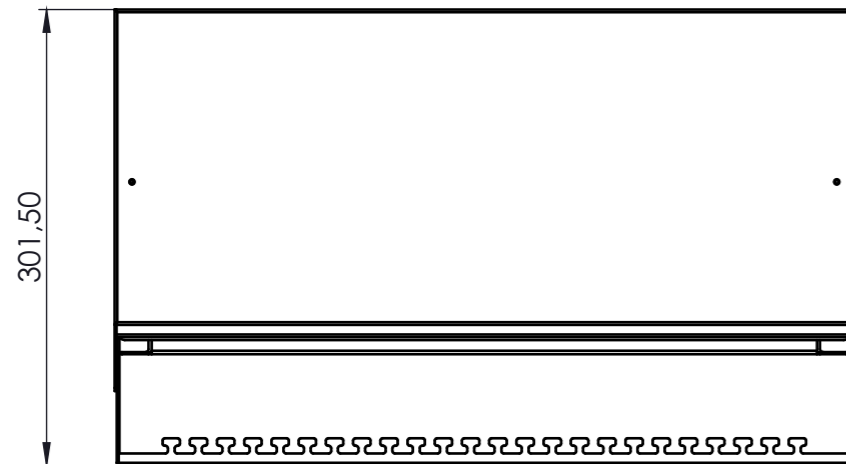
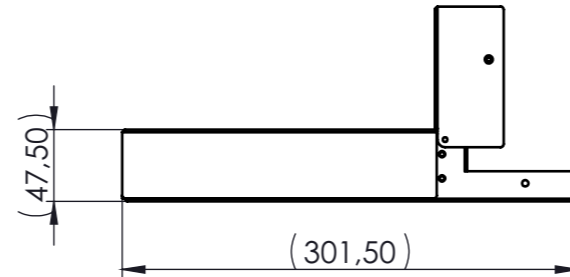
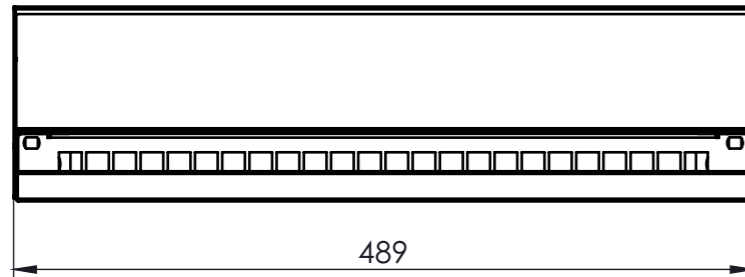

Material powder-coated sheet steel

b a	Änderung Spr. Neuerstellung	11.12.2023 13.01.2015	TG KA	drawn	01.03.2015	Andreas Kandler		
				appr.	01.03.2015			
Titel:								Dimensions: mm
Consolidation Point 19" 1U								Original: DIN A3
Drawing Number:							Sheet 1 of 1	
Rev. Index	Revision code	Date	Name	ZN-BL151024				

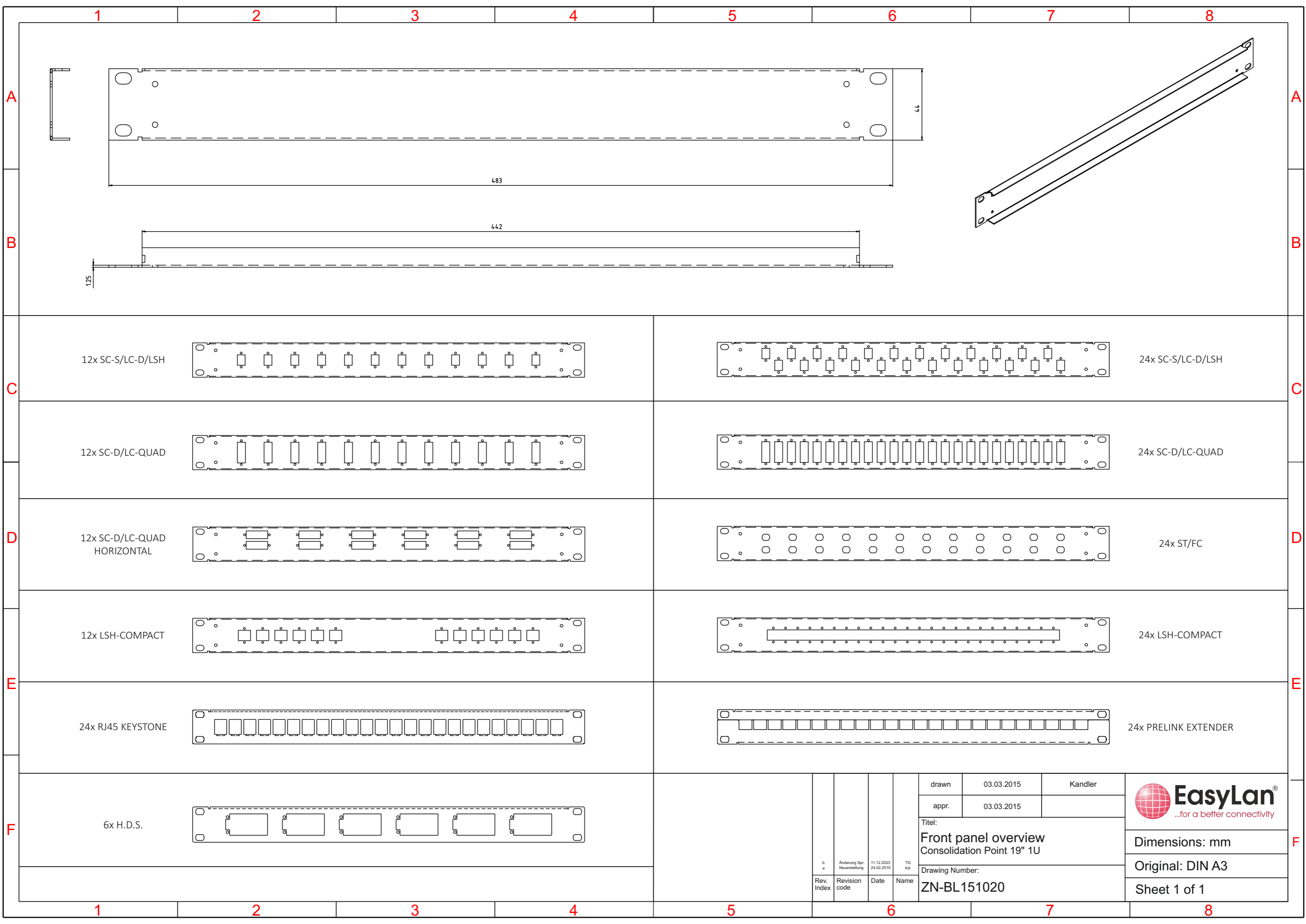

12x SC-S/LC-D/LSH

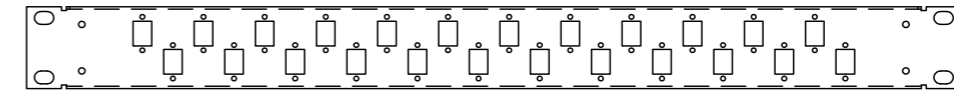
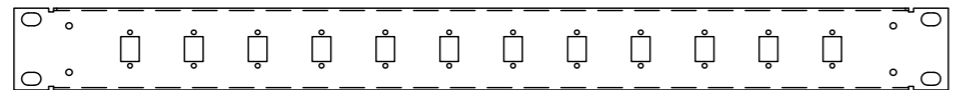

24x SC-S/LC-D/LSH

12x SC-D/LC-QUAD

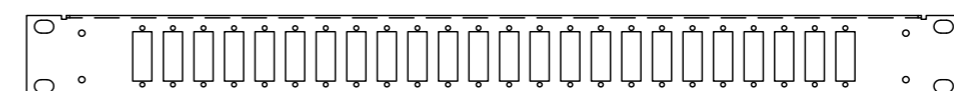
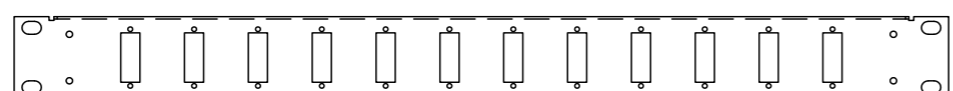

24x SC-D/LC-QUAD

12x SC-D/LC-QUAD
HORIZONTAL

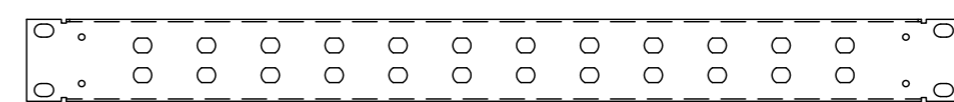
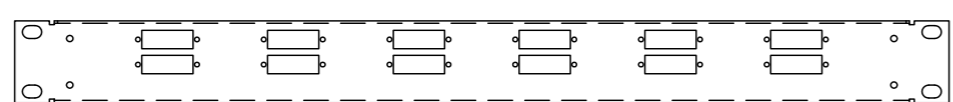

24x ST/FC

12x LSH-COMPACT

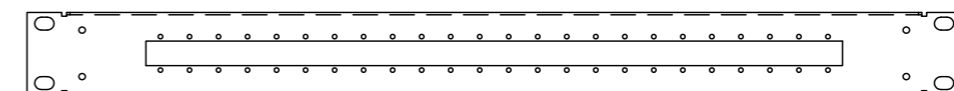
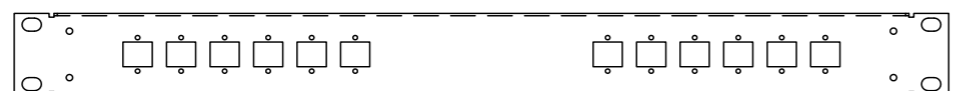

24x LSH-COMPACT

24x RJ45 KEYSTONE

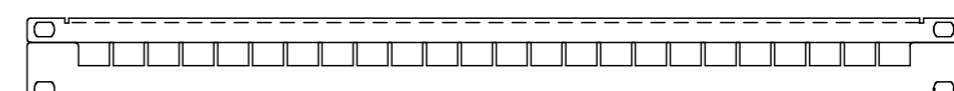
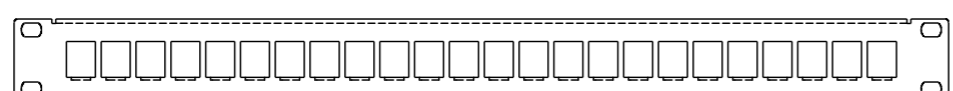

24x PRELINK EXTENDER

6x H.D.S.

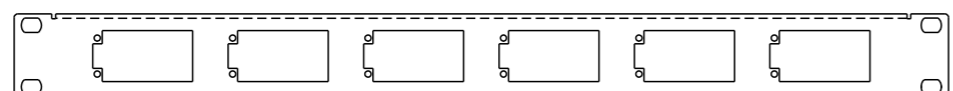

drawn	03.03.2015	Kandler
appr.	03.03.2015	
Titel: Front panel overview Consolidation Point 19" 1U		
Drawing Number: ZN-BL151020		
Rev. Index	Revision code	Date
a		11.12.2023
b	Änderung Str. Neuerstellung	24.02.2015
		TO KA



Dimensions: mm

Original: DIN A3

Sheet 1 of 1